

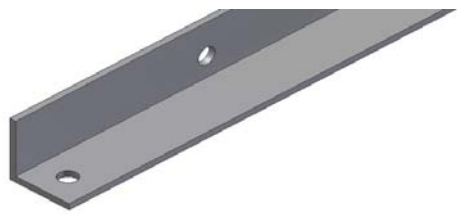





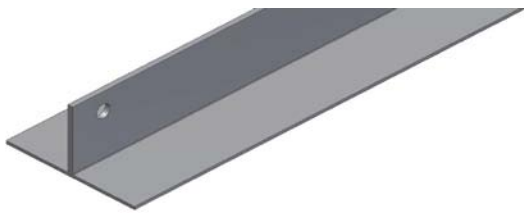
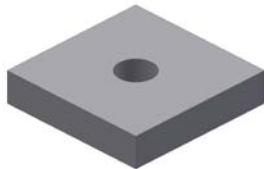

## Držák pro sluneční kolektor / Support bracket for solar collector

Rovná střecha - trojúhelníková podpěra 45° kód 6859 / Flat roof - triangle bracket 45° code 6859

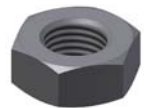
Obrázek Fig.	Označení Name	Rozměr Dimensions	Množství Qty	Kód dílu Code
	<b>Profil "L" 30x30x3</b> - hliník / L-beam 30x30x3 in aluminum	<b>Délka 1827</b> mm / Length 1827 mm	<b>1 ks / 1 piece</b>	<b>9470</b>
	<b>Profil základní "H"-</b> hliník / Basic H-beam in aluminum	<b>Délka 1310</b> mm / Length 1310 mm	<b>1 ks / 1 piece</b>	<b>11095</b>
	<b>Profil základní "T"</b> č.12197 - hliník / T- beam no.12197 aluminium	<b>Délka 1320</b> mm / Length 1320 mm	<b>1 ks / 1 piece</b>	<b>9469</b>
	<b>Podložka držáku Al</b> /Square washer for collector support, aluminum	<b>32x32 tl. 8</b> mm / 32x32, 8 mm thick	<b>2 ks / 2 pcs</b>	<b>9405</b>
	<b>Šroub M8x45 nerez</b> (imbus) DIN 912/A2 / Socket screw M8x45, stainless steel DIN 912/A2	<b>M8x45</b>	<b>2 ks / 2 pcs</b>	<b>9564</b>
	<b>Šroub M8x16 nerez</b> (imbus) DIN 912/A2 / Socket screw M8x16, stainless steel DIN 912/A2	<b>M8x16</b>	<b>1 ks / 1 piece</b>	<b>6926</b>
	<b>Matice M8 nerez</b> DIN 934/A2 / M8 Hex nut, stainless steel DIN 934/A2	<b>M8</b>	<b>5 ks / 5 pcs</b>	<b>8381</b>
	<b>Podložka 8,4 nerez</b> DIN 125/A2 / 8.4 Flat washer, stainless steel DIN 125/A2	<b>pr.8,4 mm /</b> diam. 8.4 mm	<b>3 ks / 3 pcs</b>	<b>7256</b>
	<b>Podložka vějířová</b> - vnější ozubení 8,4 DIN 6798 A/A2 nerez /Serrated tooth washer, 8.4, DIN6798 A/A2, stainless steel	<b>pr.8,4 mm /</b> diam. 8.4 mm	<b>5 ks / 5 pcs</b>	<b>8382</b>
	<b>Šroub M8x30 velká</b> hlava - pro základní profil / M8x30 bolt with big T head, for H-beam	<b>M8x30</b>	<b>2 ks / 2 pcs</b>	<b>8369</b>
	<b>Krytka H profilu / H-</b> rail end plug		<b>1 ks / 1 piece</b>	<b>11773</b>

**Sestavení držáků pro sluneční kolektory,  
pro rovné střechy - zvýšení úhlu o 45°.**

*Assembly of triangle brackets for solar collectors,  
for flat roofs - angle increase by 45°.*

Po rozbalení  
*Unpacking*

Rozložit  
*Unfolding*

Sešroubovat  
*Joining together*

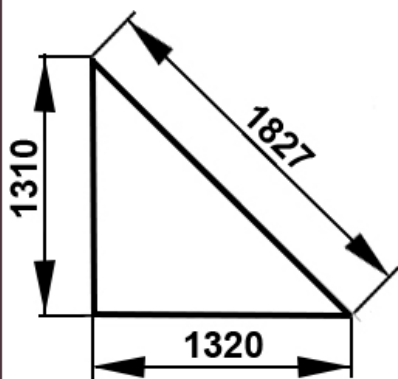
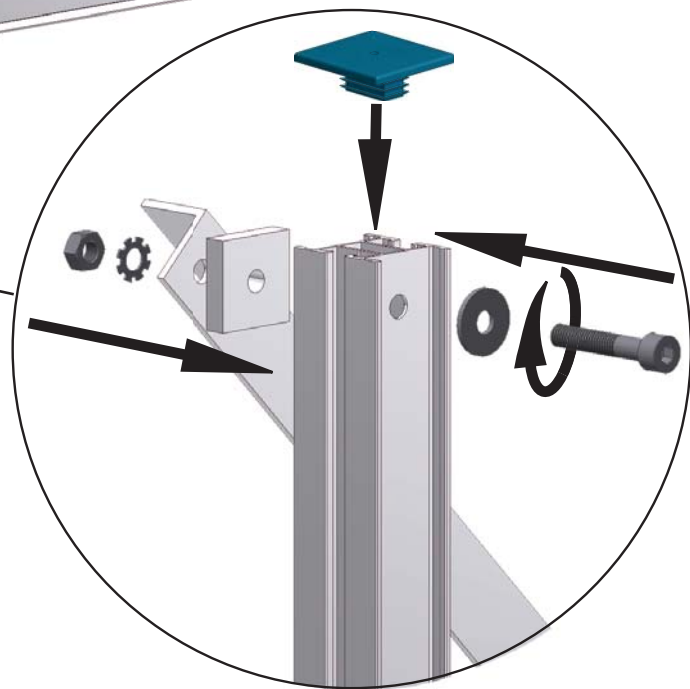
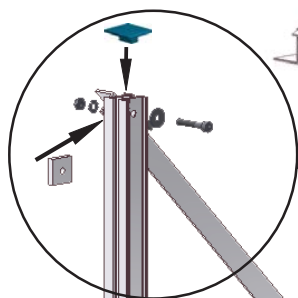

**Všechny spoje pečlivě dotáhnout!**  
*Tighten all connections meticulously!*